

Approvals & Certifications

- ASME B16.51
- IAPMO PS-117
- NSF/ANSI 61
- NSF/ANSI 372
- CSA TIL-MSE-13

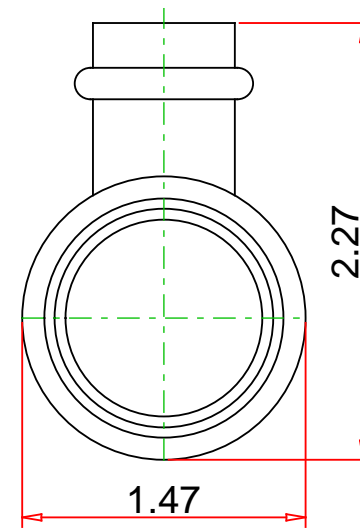
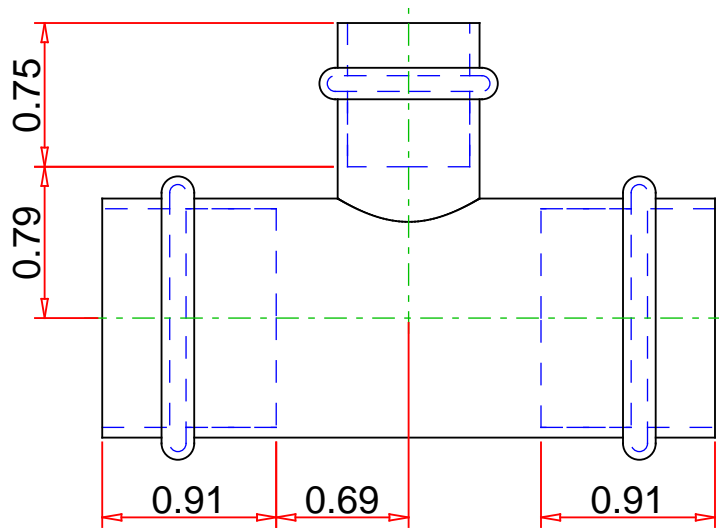
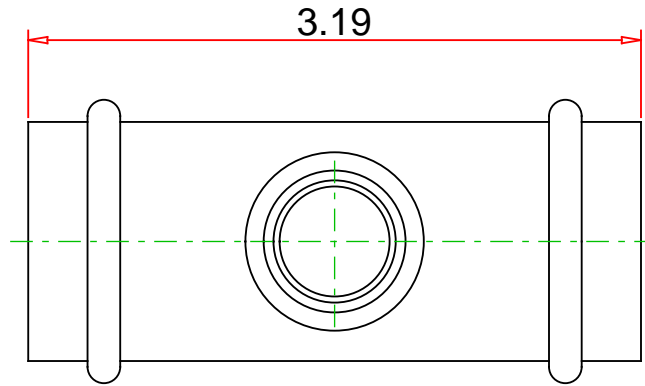

Note : - Drawing not to Scale

DISCLAIMER: DIMENSIONS ARE APPROXIMATE AND ARE SUBJECT TO CHANGE WITHOUT NOTICE.
ALL ASME DIMS ARE MINIMUM. LAY LENGTH DIMS ARE ± 0.06
ALL OTHER DIMS ARE NOMINAL. ALL DIMS ARE IN INCHES.

© 18-JUN-2019 Mueller Industries, Inc.

Part No. :

PF 04051

Description :

Copper Tee, P x P x P, 1" x 1" x 1/2"



Mueller Streamline Co.

Address : 8285 Tournament Dr., Suite 150
Memphis, TN 38125

Ph : 901-753-3200

Email : contact@muellerindustries.com

Web : <http://www.muellerindustries.com/>